



Operator's manual
Automower® Aspire™ R4

Read the operator's manual carefully and make sure that you understand the instructions before you use the product.



EN, English

Contents

1 Safety	
1.1 Safety definitions.....	3
1.2 General safety instructions.....	3
1.3 Safety instructions for installation.....	4
1.4 Safety instructions for operation.....	4
1.5 Safety instructions for maintenance.....	4
1.6 Battery safety.....	4
1.7 To lift and move the product.....	5
2 Introduction	
2.1 Introduction.....	6
2.2 Product overview.....	7
2.3 Symbols on the product.....	8
2.4 Symbols on the battery.....	8
2.5 General manual instructions.....	8
2.6 Keypad.....	8
2.7 LED indicator on the keypad.....	9
3 Installation	
3.1 Introduction - Installation.....	12
3.2 Main components for installation.....	12
3.3 To prepare for installation.....	12
3.4 Before the installation of the wires.....	12
3.5 Installation of the product.....	17
3.6 To put the wire into position with stakes.....	19
3.7 To bury the boundary wire or the guide wire.....	19
3.8 To extend the boundary wire or the guide wire... ..	19
3.9 After the installation of the product.....	20
3.10 To install the Automower® Connect app.....	20
3.11 To do the basic settings.....	20
4 Settings	
4.1 Schedule.....	21
4.2 Operation.....	21
4.3 Installation.....	22
4.4 Accessories.....	22
4.5 General.....	23
4.6 Safety.....	23
4.7 Automower® Connect	23
4.8 Download firmware over the air (Firmware over the air FOTA).....	23
5 Operation	
5.1 To use the ON/OFF button.....	24
5.2 To start the product.....	24
5.3 Operating modes.....	24
5.4 To stop the product.....	25
5.5 To set the product to OFF.....	26
5.6 To charge the battery.....	26
5.7 Cutting height adjustment.....	26
6 Maintenance	
6.1 Introduction - maintenance.....	28
6.2 Maintenance schedule.....	28
6.3 Clean the product.....	29
6.4 Replacement of the blades.....	30
6.5 Battery.....	30
6.6 Winter service.....	31
7 Troubleshooting	
7.1 Introduction - troubleshooting.....	32
7.2 Fault messages.....	32
7.3 Information and warning messages.....	36
7.4 Indicator lamp in the charging station.....	37
7.5 Symptoms.....	38
7.6 Find breaks in the loop wire.....	39
8 Transportation, storage and disposal	
8.1 Transportation.....	41
8.2 To put the product into storage.....	41
8.3 Disposal.....	41
9 Technical data	
9.1 Technical data.....	43
9.2 Registered trademarks.....	45
10 Warranty	
10.1 Warranty terms.....	46

1 Safety

1.1 Safety definitions

Warnings, cautions and notes are used to point out specially important parts of the manual.



WARNING: Used if there is a risk of injury or death for the operator or bystanders if the instructions in the manual are not obeyed.



CAUTION: Used if there is a risk of damage to the product, other materials or the adjacent area if the instructions in the manual are not obeyed.

Note: Used to give more information that is necessary in a given situation.

1.2 General safety instructions



WARNING: Read the warning instructions that follow before you use the product.

- Read the Operator's manual carefully and make sure you understand the instructions before you use the product. Keep for future reference.
 - This appliance is not intended for use by children or persons with reduced physical, sensory or mental capabilities (that could affect a safe handling of the product), or lack of experience and knowledge, unless they have been given supervision or instruction concerning use of the appliance by a person responsible for their safety. However, EU requirements allows this appliance to be used by children aged from 8 years and above and persons with reduced physical, sensory or mental capabilities or lack of experience and knowledge, if they have been given supervision or instruction concerning use of the appliance in a safe way and understand the hazards involved. Children shall not play with the appliance. Cleaning and user maintenance shall not be made by children without supervision.
 - The product must only be used with the equipment recommended by Husqvarna. All other types of use are incorrect.
 - Do not use the product when persons, especially children, or animals are in the work area.
 - Warning signs must be put around the work area of the product if it operates in public areas. The signs must have the text that follows: Warning!
- Automatic lawn mower! Keep away from the machine! Supervise children!
- Do not touch moving hazardous parts, such as the blade disc, before it has come to a complete stop.
 - Set the product to OFF before you clear a blockage, do maintenance or examine the product, and if the product starts to vibrate abnormally. Examine the product for damage before you start the product again. Do not use the product if it is damaged.
 - If an injury or accident occur, get medical aid.
 - Do not put power supply cable and extension cable in the work area. This can cause damage to the cables.
 - Do not connect a damaged cable or plug, or touch a damaged cable, before it is disconnected from the power outlet. Disconnect the plug from the power outlet if the cable becomes damaged while in operation. A worn or damaged cable increases the risk of electrical shock. A damaged cable must be replaced by service personnel.
 - When you connect the power supply to the power outlet, use a residual-current device (RCD) with a tripping current of maximum 30 mA.
 - Only charge the product in the included charging station. For safe disposal of the battery, refer to *Disposal on page 41*. Incorrect use may result in electric shock, overheating or leaking of corrosive liquid from the battery. In the event of leakage of electrolyte, flush with water/neutralizing agent. Get medical aid if corrosive liquid comes in your eyes.
 - Use only original batteries recommended by Husqvarna. Product safety cannot be guaranteed with other than original batteries. Do not use non-rechargeable batteries.
 - Follow the installation instructions that includes to specify the work area, refer to *Installation on page 12*.
 - Follow the instructions about to start and operate the product, refer to *Operation on page 24*.
 - If there is a risk of thunderstorm, Husqvarna recommends that the power supply and all the wires to the charging station are disconnected to decrease the risk of damage to electrical components. Connect the power supply and all the wires again if there is no longer a risk of thunderstorm. It is important that all wires are connected correctly.
 - Follow the maintenance instructions and if necessary use Husqvarna original spare parts, refer to *Maintenance on page 28*.
 - For technical data such as weight, dimensions and noise emission values, refer to *Technical data on page 43*.
 - The operator is responsible for accidents or dangers that occurs to other persons or property.

- The product must only be operated, maintained and repaired by persons that are fully conversant with its special characteristics and safety regulations.
- It is not permitted to change the initial design of the product.
- Obey national regulations about electrical safety.
- Husqvarna does not guarantee full compatibility between the product and other types of wireless systems such as remote controls, radio transmitters or equivalent.
- Operation and storage temperature range is 0-50 °C / 32-122 °F. Temperature range for charging is 0-45 °C / 32-113 °F. Too high temperatures can cause damage to the product.

1.3 Safety instructions for installation



WARNING: Read the warning instructions that follow before you use the product.

- Do not install the charging station, including any accessory, at a location that is below, or within 60 cm / 24 in. from, any combustible material. In case of malfunction, heating of the charging station and the power supply may occur and create a potential risk of fire.
- Do not put the power supply at a height where there is a risk it can be put in water. Do not put the power supply on the ground.
- Do not encapsulate the power supply. Condensed water can harm the power supply and increase the risk of electrical shock.
- Applicable to USA/Canada. If power supply is installed outdoors: Risk of Electric Shock. Install only to a covered Class A GFCI receptacle (RCD) that has an enclosure that is weatherproof with the attachment plug cap inserted or removed.
- Do not install the charging station where there is a risk of standing water.

1.4 Safety instructions for operation



WARNING: Read the warning instructions that follow before you use the product.

- Keep your hands and feet away from the rotating blades. Do not put your hands or feet near or below the product when it is set to ON.
- Use the park mode or set the product to OFF when persons, especially children or animals are in the work area. Refer to *Park until further notice on page 25*. Husqvarna recommends to set the product to operate when the work area has no activity. The product can cause injury to animals at

night in work area, for example hedgehogs. Refer to *Park on page 25*.

- Make sure that there are no objects such as stones, branches, tools or toys on the lawn. The blades can be damaged if it hits an object.
- Do not lift the product or move it when it is set to ON.
- Do not let the product collide with persons or animals. If a person or animal comes in the way of the product, stop the product immediately. Refer to *To stop the product on page 25*.
- Do not put objects on top of the product or its charging station.
- Do not use the product if the **STOP** button does not work.
- Always set the product to OFF when it is not in operation. The product can only start when you enter the correct PIN code.
- Do not use the product at the same time as a pop-up sprinkler. Use the *Schedule* function so the product and pop-up sprinkler do not operate at the same time. Refer to *Park on page 25*.
- Do not let the product operate when there is standing water in the work area. For example when heavy rain forms pools of water.

1.5 Safety instructions for maintenance



WARNING: Read the warning instructions that follow before you do maintenance on the product.

- Set the product to **OFF** when you do maintenance on the product.
- Do not use a high-pressure washer to clean the product. Do not use solvents to clean the product.
- Disconnect the plug to the charging station before you clean or do maintenance of the charging station.

1.6 Battery safety



WARNING: Read the warning instructions that follow before you use the product.

- Lithium-ion batteries can explode or cause fire if disassembled, short-circuited, exposed to water, fire, or high temperatures. Handle carefully, do not dismantle, open the battery or use any type of electrical/mechanical abuse. Avoid storage in direct sunlight.

1.7 To lift and move the product



WARNING: The product must be set to OFF before you lift the product. The product is disabled when the indicator on the **ON/OFF** button goes off.



CAUTION: Do not lift the product when it is parked in the charging station. It can cause damage to the charging station and/or the product. Push the **STOP** button and pull the product out of the charging station before you lift it.



To safely move the product from or in the work area:

1. Push the **STOP** button to stop the product.

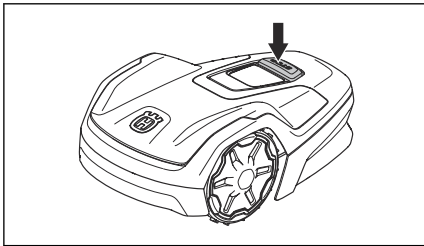

2. Push the **ON/OFF** button for 3 seconds to set the product to OFF.

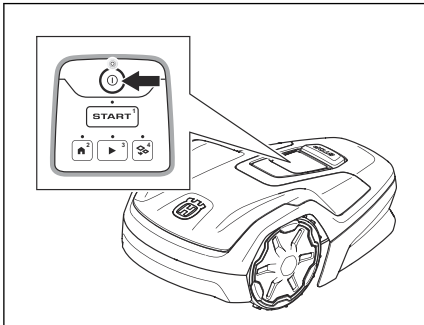

3. Make sure that the product is disabled. The indicator on the **ON/OFF** button goes off when the product is disabled. Refer to *LED indicator on the keypad on page 9*.
4. Lift the product by the handle with the blade disc away from your body.

2 Introduction

2.1 Introduction

Serial number:
Product number:
PIN code:

The serial number and the product number are on the product rating plate and on the product carton.

- Register your product on www.husqvarna.com. Enter the serial number of the product, the product number and the date of purchase to register your product.

2.1.1 Support

For support about the product, speak to your Husqvarna servicing dealer.

2.1.2 Product description

Note: Husqvarna regularly updates the appearance and function of the products. Refer to *Support on page 6*.

The product is a robotic lawn mower. The product has a battery power source and cuts the grass automatically. It continuously alternates between mowing and charging. The movement pattern is random, which means that the lawn is mowed evenly and with less wear. The boundary wire and the guide wire controls the movement of the product within the work area. Sensors in the product senses when it is approaching the boundary wire. The front of the product always passes the boundary wire by a specific distance before the product turns around. When the product hits an obstacle or approaches the boundary wire the product selects a new direction.

You can select the operation settings in the Automower® Connect or with the buttons on the keypad of the product. The app and the LED status indicator show the operation mode of the product.

The product has a maximum cutting time each day because of the maximum capacity of the product. The operation time of the product that includes to cut, search and to charge is approximately 11-12 hours each day.

2.1.2.1 Mowing technique

The frequent cutting technique improves the grass quality and decreases the use of fertilizers. Collection of grass is not necessary.

2.1.2.2 Find the charging station

The product operates until the battery state of charge is low, then the product starts to go to the charging station. The guide wire is put from the charging station to a remote part of the work area or through a narrow passage. The guide wire is connected with the boundary wire to make it easier and faster for the product to find the charging station.

2.1.2.3 Automower® Connect

Automower® Connect is a free app for your mobile device that makes it possible to select the operation settings remotely. The product can connect to the app with Bluetooth® and Wi-Fi. When you are near the product you can connect with Bluetooth®. When the product is connected to your Wi-Fi network you can control the product from everywhere. Refer to *To install the Automower® Connect app on page 20*.

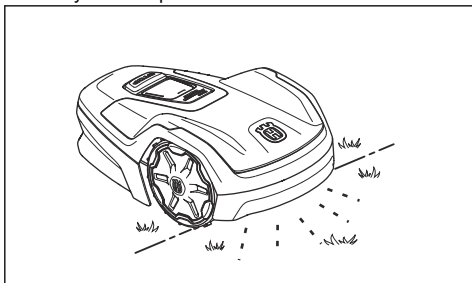

2.2 Product overview

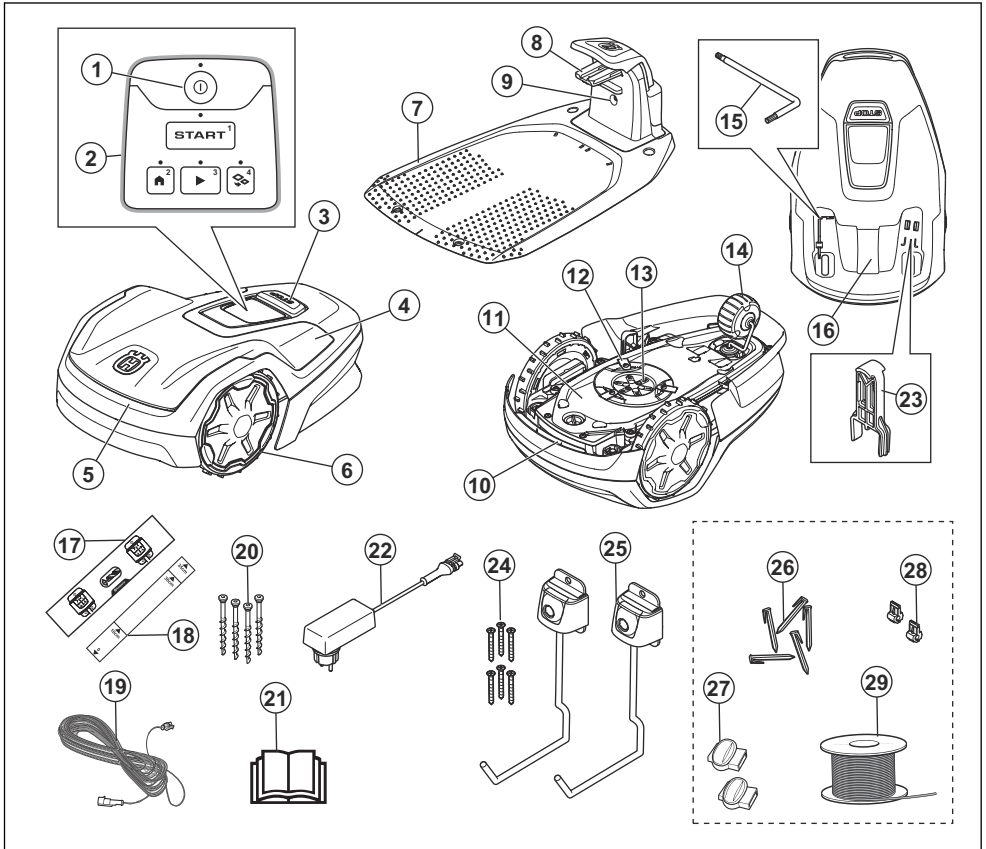

- | | |
|--|---|
| 1. ON/OFF button | 13. Blade disc |
| 2. Keypad | 14. Rear wheel |
| 3. Stop button | 15. Torx key for cutting height adjustment ¹ |
| 4. Top cover | 16. Rating plate ² |
| 5. Body | 17. Drilling template (the drilling template is removed from the carton of the product) |
| 6. Front wheels | 18. Measurement gauge for installation of the boundary wire (the measurement gauge is removed from the carton of the product) |
| 7. Charging station | 19. Low-voltage cable |
| 8. Contact plates | 20. Screws to attach the charging station |
| 9. LED for operation check of the charging station, boundary wire and guide wire | 21. Operator's Manual and Quick Guide |
| 10. Handle | 22. Power supply ³ |
| 11. Chassis box with electronics, battery and motors | |
| 12. Cutting system | |
| | 23. Torx key |
| | 24. Screws |
| | 25. Power supply |
| | 26. Torx key |
| | 27. Screws |
| | 28. Torx key |
| | 29. Spool of boundary wire |

¹ Found below the top cover. The top cover must be removed to access it.

² Found below the top cover. The top cover must be removed to access it.

³ The appearance can be different for different markets.

23. Maintenance tool⁴
24. Screws to attach the storage hook
25. Storage hook
26. Stakes⁵
27. Couplers for the loop wire⁶
28. Connectors for the loop wire⁷
29. Loop wire for boundary wire and guide wire⁸



The chassis contains components which are sensitive to electrostatic discharge (ESD). The chassis must only be opened and sealed by an authorized service technician. The warranty will not be applicable if the seal is broken.

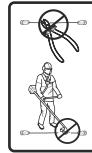

Do not make modifications on the low-voltage cable.

Do not use a hedge trimmer or a grass trimmer near the low-voltage cable.

2.3 Symbols on the product

These symbols can be found on the product. Make sure that you understand them.



WARNING: Read the operator instructions before you operate the product.



WARNING: Disable the product before maintenance or before you lift the product.



WARNING: Keep a safe distance from the product when it is in operation. Keep your hands and feet away from the rotating blades of the product.



WARNING: Do not sit on the product. Do not put your hands or feet near or below the product.

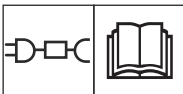

Use a detachable power supply as specified on the rating plate adjacent to the symbol.



This product complies with the applicable EU Directives.



This product complies with the applicable UK Directives.



It is not permitted to dispose the product as usual domestic waste. Obey national regulations and use the local recycling system.

2.4 Symbols on the battery



WARNING: Lithium-ion batteries can explode or cause fire if disassembled, short-circuited or handled roughly. Do not expose to water, fire or high temperature.



Read the user instructions.



Do not discard the battery into fire and do not expose the battery to a heat source.



Do not immerse the battery into water.

2.5 General manual instructions

The following system is used in the Operator's Manual to make it easier to use:

- Text written in *italics* is a text that is shown in the display or is a reference to another section in the Operator's Manual.
- Text written in **bold** is one of the buttons on the product.

2.6 Keypad

The keypad on the product is used to enter the PIN code and to select an operation mode for the product. Refer to *Operating modes on page 24*. The buttons on the

⁴ Found below the top cover. The top cover must be removed to access it.

⁵ Only included in the installation kit.

⁶ Only included in the installation kit.

⁷ Only included in the installation kit.

⁸ Only included in the installation kit.

keypad with flashing lights are the available operating modes for the product that you can select. You must enter the PIN code for the product before you can select an operating mode. The buttons that have a number are used to enter the PIN code. Refer to *PIN code on page 23*.

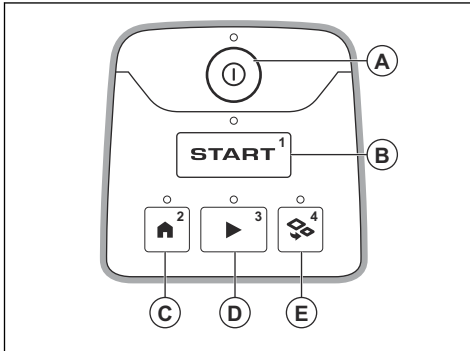

- The **ON/OFF** button (A) is used to set the product to ON or to OFF.
- The **Start** button (B) is used to start the operation of the product.
- The **Park** button (C) is used to send the product to the charging station.
- The **Play** button (D) is used to cut the main area.
- The **Secondary area** button (E) is used to cut the secondary area.

2.7 LED indicator on the keypad

The LED indicator on the keypad shows the product status. There are 5 light modes on the LED indicator: the light flashes quickly (A), the light is solid (B), the light flashes slowly (C), the light is out (D), and the light pulsates (E).

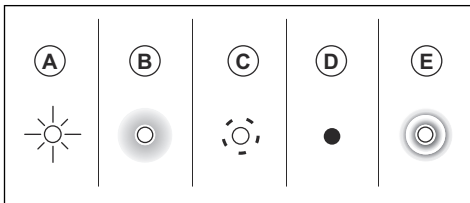

Standby: When the product is not in use for 3 minutes, the product sets to standby mode.

Idle: The product is ON and in idle mode until you select an operating mode.

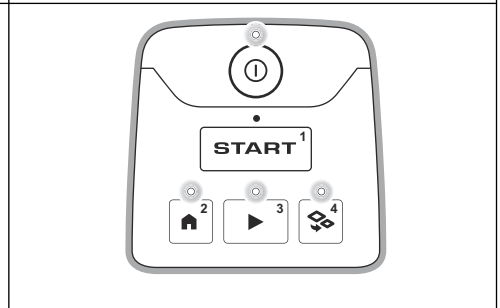
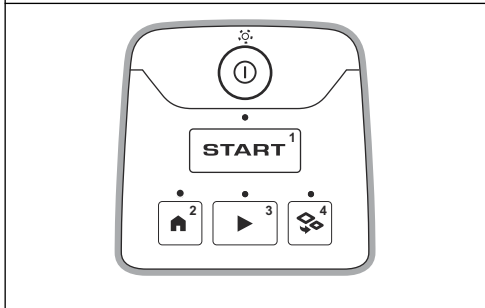

Waiting for PIN code.

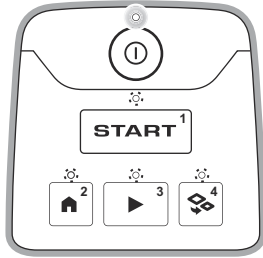

Cutting main area as specified in the set *Schedule* or *Override Schedule*.

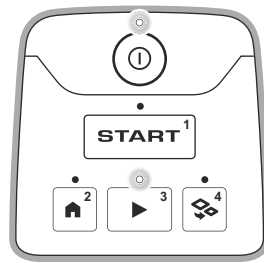

Parked, until *Next schedule* or until *Further notice*.

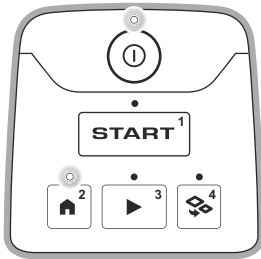

Cutting *Secondary* area.



Firmware installation in progress.

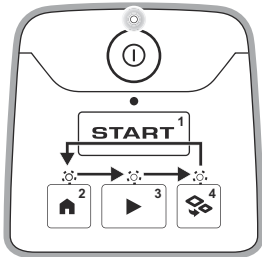

Error. LED indicator flashes continuously.

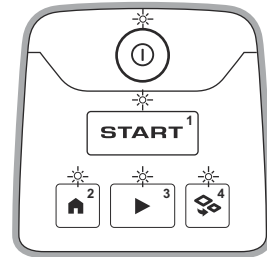

Firmware installation error. The LED indicator flashes quickly 4 times, stops and then flashes quickly 4 times again continuously.

Charging

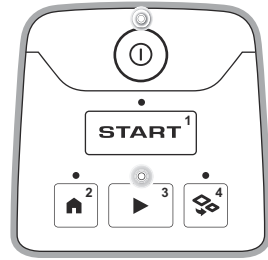
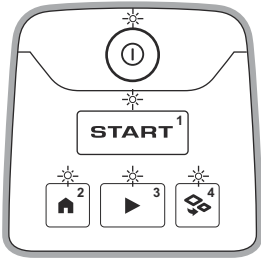

3 Installation

3.1 Introduction - Installation

Refer to www.husqvarna.com for more information about installation and instruction videos.

We recommend you to update the firmware before you install the product to make sure that the product has the latest firmware. Refer to *Download firmware over the air (Firmware over the air FOTA) on page 23.*



WARNING: Read and understand the safety chapter before you install the product.



CAUTION: Use original spare parts and installation material.

3.2 Main components for installation

The installation involves the following components:

- A robotic lawn mower that mows the lawn automatically.
- A charging station, which has 3 functions:
 - To send control signals along the boundary wire.
 - To send control signals along the guide wire so that the product can follow the guide wire to specific remote areas in the garden and can find its way back to the charging station.
 - To charge the product.
- A power supply, which is connected to the charging station and a 100-240V power outlet.
- Loop wire, which is laid around the work area and around objects and plants that the product must not run into. The loop wire is used both as boundary wire and guide wire.

3.3 To prepare for installation

Read the installation chapter before you start the installation. Prepare the installation carefully to make the product operate satisfactorily.

- Make a blueprint of the work area and include all obstacles. This makes it easier to examine where to put the charging station, the boundary wire and the guide wire.
- Make a mark on the blueprint where to put the charging station, the boundary wire and the guide wire.
- Make a mark on the blueprint where the guide wire connects to the boundary wire. Refer to *To install the guide wire on page 18.*
- Fill in holes in the lawn to make the ground level.



CAUTION: Holes with water in the lawn can cause damage to the product.

- Make sure that the product has Wi-Fi coverage when it is in the charging station. Refer to *Download firmware over the air (Firmware over the air FOTA) on page 23.*

Note: New firmware only downloads when the product is in the charging station.

- Make sure that you have Wi-Fi coverage in the work area if you use the Automower® Connect app remotely. Refer to *Automower® Connect on page 6.*

Note: We recommend you to have Wi-Fi coverage in the work area. If you have Wi-Fi coverage, you can control and make settings for the product remotely with the Automower® Connect app. The product automatically connects to Wi-Fi when it is in an area that has Wi-Fi coverage.

- Cut the grass before you install the product. Make sure that the grass is maximum 4 cm / 1.6 in.

Note: The first weeks after installation the sound level when the product cuts the grass can be higher than usual. The sound level decreases after some time.

3.4 Before the installation of the wires

You can select to attach the wires with stakes or bury them. You can use the 2 procedures for the same work area.



CAUTION: If you use a dethatcher in the work area, bury the boundary wire and the guide wire to prevent them from damage.

3.4.1 To examine where to put the charging station

- Keep a minimum 2 m / 6.6 ft. of free space in front of the charging station. Refer to *To examine where to put the guide wire on page 16.*
- Keep a minimum of 30 cm / 12 in. of free space to the right and left of the center of the charging station.

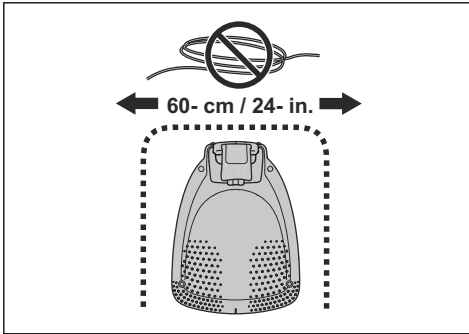

- Put the charging station near a power outlet.
- Put the charging station on a level surface.
- The baseplate of the charging station must not be bent.

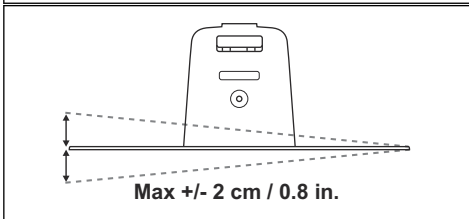
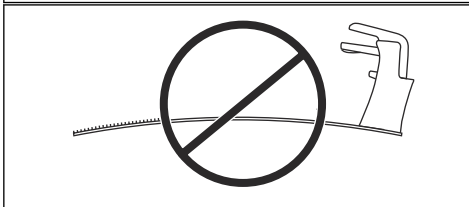
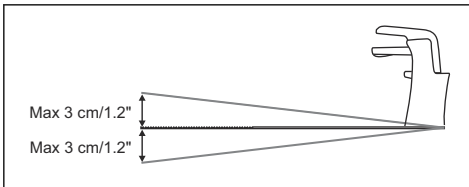

- If the work area has two parts separated with a steep slope, we recommend to put the charging station in the lower section.
- Put the charging station in an area with protection from the sun.
- Put the charging station where there is Wi-Fi coverage to download new firmware. Refer to *Download firmware over the air (Firmware over the air FOTA) on page 23*.
- If the charging station is installed on an island, make sure to connect the guide wire to the island. Refer to *Mowing technique on page 6*.

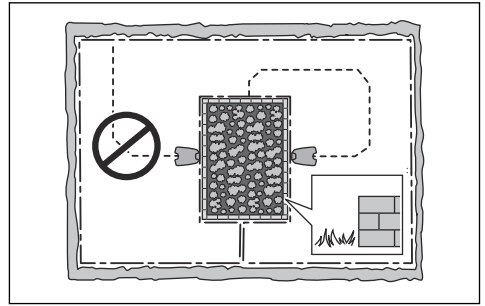

3.4.2 To examine where to put the power supply



WARNING: Do not cut or extend the low-voltage cable. There is a risk of electrical shock.



CAUTION: Make sure that the blades on the product do not cut the low-voltage cable.



CAUTION: Do not put the low-voltage cable in a coil or below the charging station plate. The coil causes interference with the signal from the charging station.

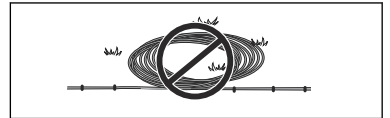

- Put the power supply in an area with a roof and protection from the sun and rain.
- Put the power supply in an area with good airflow.
- Use a residual-current device (RCD) with a tripping current of maximum 30 mA when you connect the power supply to the power outlet.

Low-voltage cables of different lengths are available as accessories.

3.4.3 To examine where to put the boundary wire



CAUTION: There must be a barrier of minimum 15 cm / 6 in. in height between the boundary wire and water bodies, slopes, precipices or public roads. This will prevent damage to the product.



CAUTION: Do not let the product operate on gravel.



CAUTION: Do not make sharp bends when you install the boundary wire.



CAUTION: For careful operation without noise, isolate all obstacles such as trees, roots and stones.

The boundary wire should be put as a loop around the work area. Sensors in the product senses when the product approaches the boundary wire, and the product selects another direction. All parts of the work area must be maximum 15 m / 50 ft. from the boundary wire.

To make the connection easier between the guide wire and the boundary wire, it is recommended to make an eyelet where the guide wire will be connected. Make the eyelet with approximately 20 cm / 8 in. of the boundary wire.

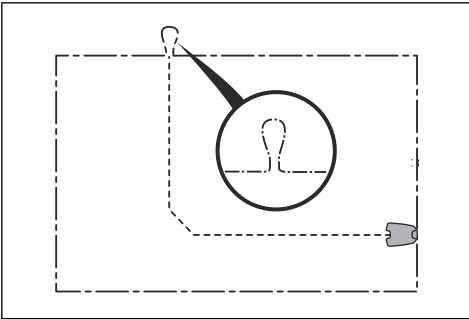

Note: Make a blueprint of the work area before you install the boundary wire and guide wire.

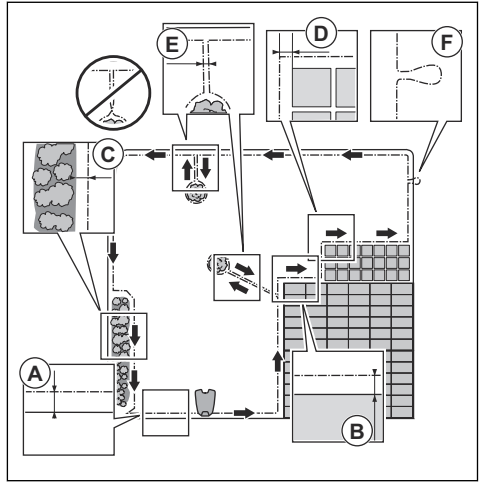

- Put the boundary wire around all of the work area (A). Adapt the distance between the boundary wire and obstacles.
- Put the boundary wire 35 cm / 14 in. (B) from an obstacle that is more than 3.5 cm / 1.4 in. high.

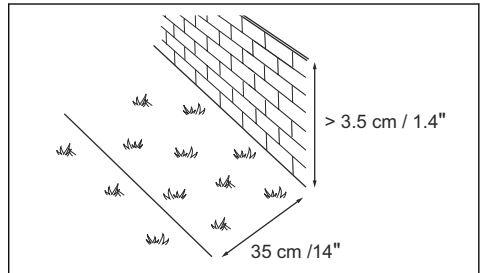

- Put the boundary wire 30 cm / 12 in. (C) from an obstacle that is 1-3.5 cm / 0.4-1.4 in. high.

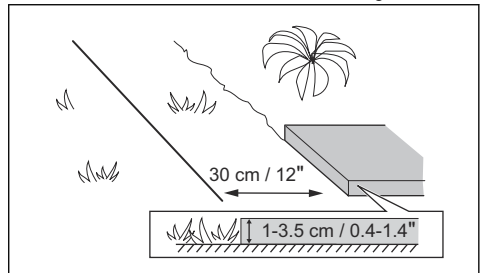

- Put the boundary wire 10 cm / 4 in. (D) from an obstacle that is less than 1 cm / 0.4 in. high.

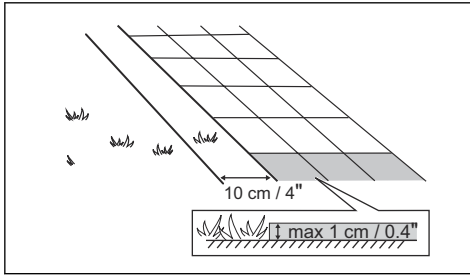

- If you have a paving stone path that is in level with the lawn, put the boundary wire below the paving stone.

Note: If the paving stone is minimum 30 cm / 12 in. wide, use the factory setting for the *Drive Past Wire* function to cut all the grass adjacent to the paving stone. Refer to *Drive Past Wire function* on page 22.

- If you make an island, put the boundary wire that runs to and from the island near together (E). Put the wires in the same stake. Refer to *To make an island* on page 15.
- Make an eyelet (F) where the guide wire is to be connected to the boundary wire.

3.4.3.1 To put the boundary wire in a slope

The product can operate in 25% slopes. Slopes that are too steep must be isolated with the boundary wire. The gradient (%) is calculated as height per m. Example: 10 cm / 100 cm = 10%.

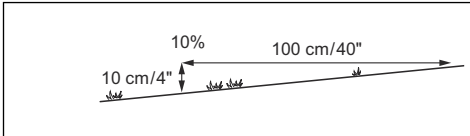

- For slopes steeper than 25% inside the work area, isolate the slope with boundary wire.
- For slopes steeper than 10% along the outer edge of the lawn, put the boundary wire 20 cm / 8 in. (A) from the edge.
- For slopes adjacent to a public road, put a barrier of minimum 15 cm / 6 in. along the outer edge of the slope. You can use a wall or a fence as a barrier.

3.4.3.2 Passages

A passage is a section that has boundary wire on each side and that connects 2 parts of the work area. The distance between the boundary wire on each side in the passage must be a minimum of 60 cm / 24 in.

Note: If a passage is less than 2 m / 6.5 ft. wide, install a guide wire through the passage.

The recommended minimum distance between the guide wire and the boundary wire is 30 cm / 12 in. The product always runs to the left of the guide wire as seen facing the charging station. It is recommended to have as much free area as possible to the left of the guide wire (A).

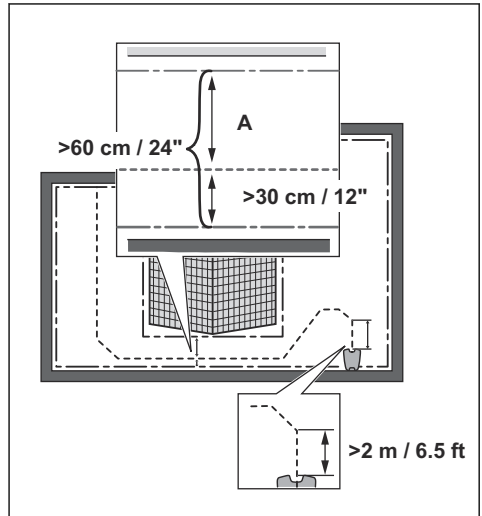

3.4.3.3 To make an island



CAUTION: Do not put a section of boundary wire across the other. The sections of boundary wire must be parallel.



CAUTION: Do not put the guide wire across the boundary wire.



CAUTION: Isolate or remove obstacles that are less than 15 cm / 5.9 in. in height. Isolate or remove obstacles that slope slightly, for example, stones, trees or roots. This will prevent damage to the blades of the product.

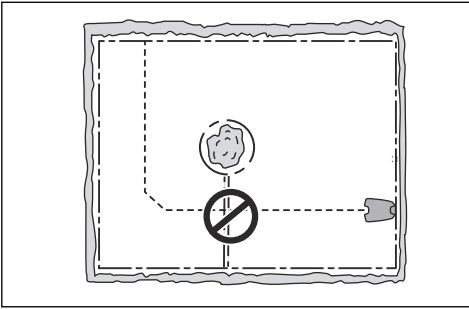

To make an island, isolate areas in the work area with the boundary wire. We recommend to isolate all stable objects in the work area.

Some obstacles are resistant to a collision, for example, trees or bushes that are more than 15 cm / 5.9 in. in height. The product will collide with the obstacle and then select a new direction.

- Put the boundary wire to and around the obstacle to make an island.
- Put the 2 sections of boundary wire to and from the island close together. This will make the product run across the wire.
- Put the 2 sections of boundary wire in the same stake.

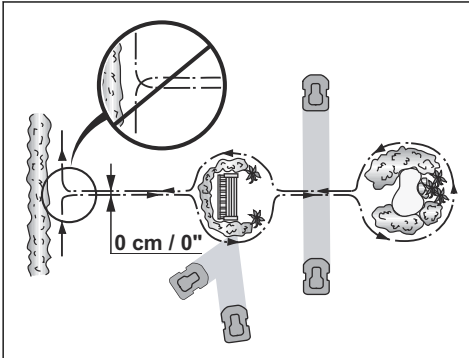

3.4.3.4 To make a secondary area

Make a secondary area (B) if the work area has 2 areas that are not connected with a passage. The work area with the charging station is the main area (A).

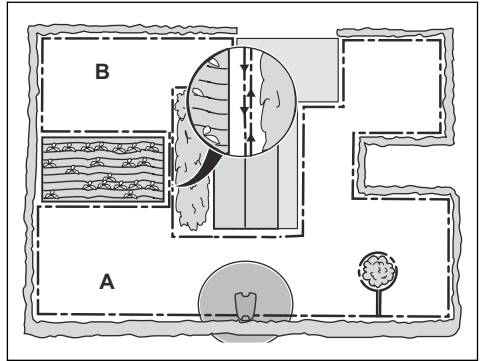

Note: The product must be manually moved between the main area and the secondary area.

- Put the boundary wire around the secondary area (B) to make an island. Refer to *To make an island on page 15*.

Note: The boundary wire must be put as 1 loop around all of the work area (A + B).

Note: When the product cuts grass in the secondary area, the *Secondary area mode* must be selected. Refer to *Secondary area on page 24*.

3.4.4 To examine where to put the guide wire

Put the guide wire from the charging station through the work area and connect it to the boundary wire.

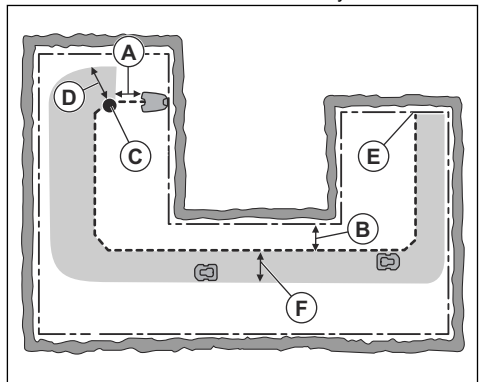

- Put the guide wire in a line at a minimum of 1 m / 3.3 ft. in front of the charging station (A).
- Put the guide wire minimum 30 cm / 1 ft. from the boundary wire (B).

- Starting point (C). Refer to *To set the starting point on page 22*.
- Minimum distance 60 cm / 2 ft. from the starting point to perpendicular to the boundary wire (D). Refer to *Support on page 6*.
- Minimum distance 60 cm / 2 ft. perpendicular to the guide wire (D).
- Where the guide wire is connected to the boundary wire (E).
- Guide corridor (F). The product always runs to the left of the guide wire as seen facing the charging station. Make sure that the guide wire has as much free area as possible to the left of the guide wire. The guide corridor can be maximum 1.2 m / 4 ft.

Note: The product always runs in the guide corridor but changes the distance to the guide wire.

- Do not make sharp bends when you install the guide wire.

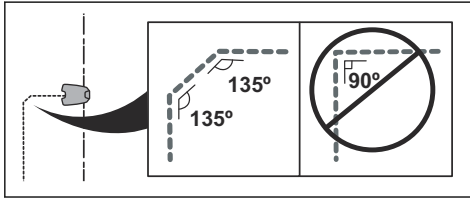

3.4.5 Work area examples

- If the charging station is put in a small area (A), make sure that the distance to the boundary wire is at a minimum 2 m / 6.6 ft. in front of the charging station.
- If the work area has a passage (B) with no guide wire installed, the minimum distance between the boundary wires is 2 m / 6.5 ft. With a guide wire installed through the passage, the minimum distance between the boundary wires is 60 cm / 24 in.
- If the work area has areas which are connected by a narrow passage (B), you can set the product to first follow and then leave the guide wire after a certain distance (C). The settings can be changed in *Lawn Coverage and Systematic Passage Mowing on page 22*.
- If the work area includes a secondary area (D), refer to *Secondary area on page 24*. Put the product in the secondary area and select *Secondary area mode*.

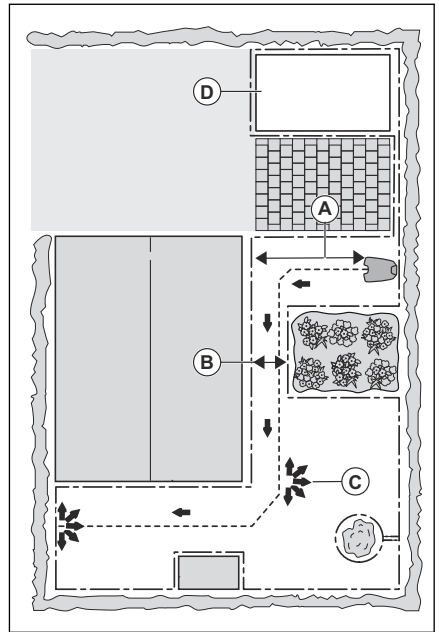

3.5 Installation of the product

3.5.1 Installation tools

- Hammer/plastic mallet: To simplify putting the stakes into the ground.
- Edge cutter/straight spade: To bury the boundary wire.
- Combination pliers: For cutting the boundary wire and pressing the connectors together.
- Adjustable plier: For pressing the couplers together.

3.5.2 To install the charging station



CAUTION: Do not make new holes in the charging station plate.



CAUTION: Do not put your feet on the baseplate of the charging station.



WARNING: Make sure that the plugs of the low-voltage cable and the power supply unit are clean and dry before you connect them.

When connecting the power supply, only use a power outlet that is connected to an residual-current (RCD) device.

1. Read and understand the instructions about the charging station. Refer to *To examine where to put the charging station on page 12*.
2. Put the charging station in the selected area.

Note: Do not attach the charging station to the ground with the screws until the guide wire is installed. Refer to *To install the guide wire on page 18*.

3. Connect the low-voltage cable to the charging station.
4. Put the power supply at a minimum height of 30 cm / 12 in.

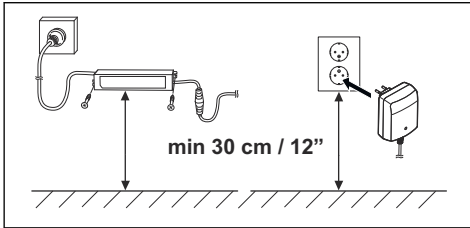

5. Connect the power supply cable to a 100-240V power outlet.

Note: The product can be put in the charging station to charge while you install the boundary wire and the guide wire.

6. Put the low-voltage cable in the ground with stakes or bury the cable. Refer to *To put the wire into position with stakes on page 19* or *To bury the boundary wire or the guide wire on page 19*.
7. Connect the wires to the charging station after the installation of boundary wire and guide wire is complete. Refer to *To install the boundary wire on page 18* and *To install the guide wire on page 18*.
8. Attach the charging station to the ground with the supplied screws after the guide wire is installed. Refer to *Safety instructions for operation on page 4*.

3.5.3 To install the boundary wire



CAUTION: Do not put remaining wire in a coil. The coil causes interference with the product.

1. Put the boundary wire around all of the work area. Start and complete the installation behind the charging station.

2. Open the connector and put the boundary wire in the connector.

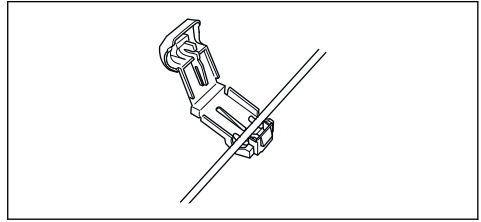

3. Close the connector with a pair of pliers.

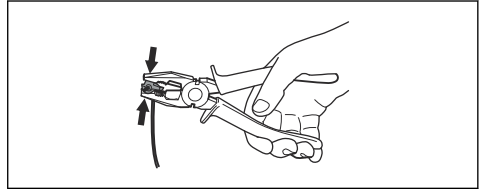

4. Cut the boundary wire 1-2 cm / 0.4-0.8 in. above each connector.
5. Push the right connector onto the metal pin on the charging station with the mark "R".
6. Push the left connector onto the metal pin on the charging station with the mark "L".

3.5.4 To install the guide wire



CAUTION: Twinned cables, or a screw terminal block that is insulated with insulation tape are not satisfactory splices. Soil moisture will cause the wire to oxidize and after a time result in a broken circuit.

1. Open the connector and put the wire in the connector.
2. Close the connector with a pair of pliers.
3. Cut the guide wire 1-2 cm / 0.4-0.8 in. above each connector.
4. Push the guide wire through the slot in the charging station plate.
5. Push the connector onto the metal pin on the charging station with the mark "G".
6. Disconnect the charging station from the power outlet.
7. Put the end of the guide wire at the eyelet on the boundary wire.
8. Cut the boundary wire with a pair of wire cutters.
9. Connect the guide wire to the boundary wire with a coupler.

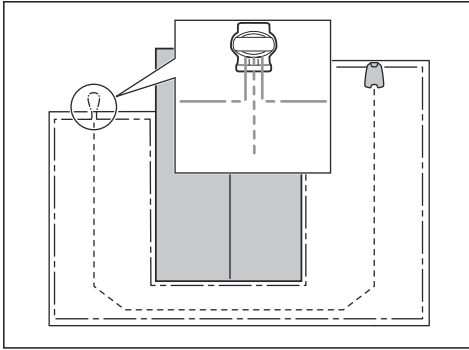

- a) Put the 2 ends of the boundary wire and the end of the guide wire into the coupler.

Note: Make sure that you can see the ends of the wires through the transparent area of the coupler.

- b) Push down the cover on the coupler with adjustable pliers to attach the wires in the coupler.

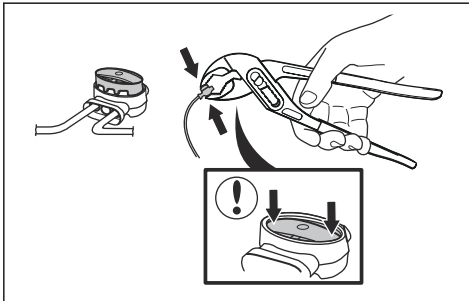

10. Attach the guide wire to the ground with stakes or bury the guide wire in the ground. Refer to *To put the wire into position with stakes on page 19* or *To bury the boundary wire or the guide wire on page 19*.

11. Connect the charging station to the power outlet.

3.6 To put the wire into position with stakes



CAUTION: Make sure that the stakes hold the boundary wire and the guide wire against the ground.



CAUTION: Cutting the grass too low right after installation can damage the wire insulation. Damage to the insulation may

not cause disruptions until several weeks or months later.

1. Put the boundary wire and the guide wire on the ground.
2. Put the stakes at a maximum of 75 cm / 30 in. distance from each other.
3. Attach the stakes to the ground with a hammer or a plastic mallet.

Note: The wire is overgrown with grass and not visible after a few weeks.

3.7 To bury the boundary wire or the guide wire

- Cut a groove in the ground with an edge cutter or a straight shovel.
- Put the boundary wire or the guide wire 1-20 cm / 0.4-8 in. into the ground.

3.8 To extend the boundary wire or the guide wire

Note: Extend the boundary wire or the guide wire if it is too short for the work area. Use original spare parts, for example couplers.

1. Disconnect the charging station from the power outlet.
2. Cut the boundary wire or the guide wire with a pair of wire cutters where it is necessary to install the extension.
3. Add wire where it is necessary to install the extension.
4. Put the boundary wire or the guide wire into position.
5. Put the wire ends into a coupler.

Note: Make sure that you can see the ends of the boundary wire or the guide wire through the transparent area of the coupler.

6. Push down the cover on the coupler with adjustable pliers to attach the wires in the coupler.

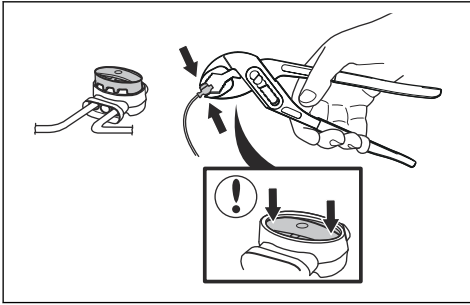

5. Enter the factory PIN code 1234.

Note: We recommend that you change the factory PIN code to a personal PIN code. Refer to *PIN code on page 23*.

6. Follow the instructions in the app to make settings, select your Wi-Fi network and to connect to Husqvarna Cloud.

Note: It is only necessary to do a pairing operation of the Automower® Connect app and the product one time.

7. Put the boundary wire or the guide wire into position with stakes.
8. Connect the charging station to the power outlet.

3.9 After the installation of the product

3.9.1 To do a visual check of the charging station

1. Make sure that the indicator LED lamp on the charging station has a green light.
2. If the indicator LED lamp does not have a green light, do a check of the installation. Refer to *Indicator lamp in the charging station on page 37* and *To install the charging station on page 17*.

3.10 To install the Automower® Connect app

1. Download the Automower® Connect app on your mobile device.
2. Sign up for a Husqvarna account in the Automower® Connect app.
3. An e-mail is sent to the registered e-mail address. Follow the instructions in the e-mail in less than 24 hours to validate your account.
4. Log in to your Husqvarna account in the Automower® Connect app.

3.11 To do the basic settings

1. Set the product to ON.

Note: The Bluetooth® pairing operation mode of the product is enabled for 3 minutes. If the pairing operation between the product and the mobile device is not completed correctly, restart the product to enable Bluetooth® again.

2. Log on to your Husqvarna account in the Automower® Connect app.
3. Start Bluetooth® on your mobile device.
4. Select *My mowers* in the Automower® Connect app, and add your product.

4 Settings

Use the Automower® Connect app for product settings. The factory settings are applicable for almost all work areas, but the settings can be adapted to the conditions for each work area.

4.1 Schedule



In *Schedule* you can change the schedule settings for the product.

The *Schedule* function controls which hours the product operates. When the product does not operate, it is parked in the charging station. You can see which hours and days the product operates in the schedule overview in the app.

You can set the Schedule if the work area is less than the maximum area capacity of the product. This prevents wear on the grass and the product. The factory schedule setting lets the product to operate around the clock 7 days a week.

To calculate the schedule setting, refer to *Schedule on page 21*.

4.1.1 Make an estimate of the necessary operating time

If the work area is less than maximum product capacity, the schedule must be set to decrease the wear on the lawn and the product. The product has a maximum cutting time each day. You can set the operating time of the product in the schedule. The operating time includes cutting, searching and charging. The operating time can be different because of many reasons, for example the layout of the work area, the grass growth and age of the battery. When the product has operated to the maximum cutting time in a day, the message *Today's mowing complete* is shown in the display of the app.

The recommended operating times for some work area examples are shown in the table below. If the result is not satisfactory, increase the operating time.

Area, m ²	Recommended operating time, h
200	5-6
400	11-12

4.2 Operation



In *Operation* you can change the operation settings of the product.

4.2.1 Weather timer

Weather timer automatically adjust the cutting time to the growth of the grass. The product is not permitted to operate more than the schedule settings.

Note: When using *Weather timer*, it is recommended to make as much operating time as possible available for *Weather timer*. Do not restrict the schedule more than necessary.

The first operation of the day is set by the schedule settings. The product always complete 1 mowing cycle, and then *Weather timer* selects if the product will continue to operate or not.

Note: *Weather timer* is reset if the product does not operate for more than 50 hours, or if a *Reset of all user settings* is done. *Weather timer* is not changed if a *Reset of schedule settings* is done.

4.2.2 ECO mode

If *ECO mode* is activated, it switches off the signal in the boundary loop, the guide wire and the charging station, when the product is parked or is charging. In the factory setting this function is disabled.

Note: Use *ECO mode* to save energy and avoid interference with other equipment, for example hearing loops or garage doors.

Note: To start the product manually in the work area, push the **STOP** button before you remove the product from the charging station. If not, the product can not be started in the work area.

4.2.3 Frost Guard

The grass is more sensitive to wear if there is frost on the grass. If the *Frost Guard* is enabled, the product does not start to cut the grass if the temperature is less than 5° C / 41° F.

Note: The frost sensor is at the inner side of the chassis. There can be a temperature difference compared to the ambient temperature.

4.3 Installation



In *Installation* you can change the installation settings of the product.

4.3.1 Lawn Coverage and Systematic Passage Mowing

If the work area includes remote parts that are connected with narrow passages, the *Lawn Coverage* and *Systematic Passage Mowing* function are useful to be able to maintain a well-cut lawn in all parts of the yard. The *Lawn Coverage* function is used to guide the product to remote parts of the work area. The *Systematic Passage Mowing* function is used for narrow passage mowing. A guide wire must be installed to use these functions. You can set a maximum of 3 remote areas.

With the *Lawn Coverage* function the product first follows and then leaves the guide wire after a certain distance and starts to mow the lawn.

The *Systematic Passage Mowing* function is suitable to mow narrow passages of 60 cm - 1.5 m / 2 in. - 4.9 ft. width. The product moves in a pattern to cover the passage width. The product starts the *Systematic Passage Mowing* at the set distance from the charging station. When the product reaches the end of the narrow passage, the product continues and cuts the lawn as normal.

Area A, approximately 50%

Area B, approximately 30%

Area C, approximately 20%

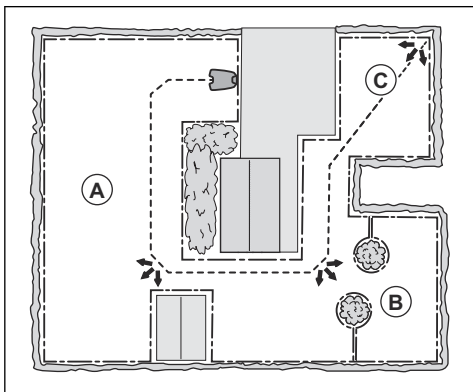

4.3.2 To set the starting point

The product starts to operate at the starting point. The starting point is set to control how far the product moves along the guide wire from the charging station. The product straddles the guide wire from the charging station to the starting point. The factory setting is 60 cm / 2 ft.

- Set the starting point at a short distance from the charging station to prevent tracks on the lawn.
- If the charging station is put in a small area, set the starting point (A) where the minimum distance (B) to the boundary wire is 60 cm / 2 ft.

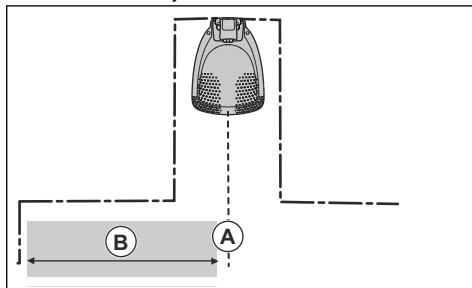

4.3.3 Drive Past Wire function

The front of the product always moves past the boundary wire by a specified distance. Then the product moves rearward and changes direction. The factory setting is 32 cm / 12 in. You can select a distance of 20-35 cm / 8-14 in.

Note: If you change the distance for *Drive Past Wire*, the distance will change along the boundary wire in all parts of the work area.

4.4 Accessories



In *Accessories* you can change the settings of the product accessories.

4.4.1 Avoid collisions with Husqvarna mower house

If you have installed a Husqvarna mower house⁹, the wear on the product and the mower house decreases when you select *Avoid house collisions*. In the factory setting this function is disabled.

⁹ Available as accessory

Note: If *Avoid house collisions* is selected it can result in grass that is not cut around the charging station.

4.4.2 FlexiFence

If you install the FlexiFence accessory, you must enable the FlexiFence function in the Automower® Connect app.

4.5 General



In the *General* menu you can set the time and date, or reset to factory settings.

This menu is only available when your mobile device is connected to the product with Bluetooth®.

4.5.1 Time & date

The time and date can be changed manually, or by using the time and date from the mobile device.

4.5.2 Reset to factory settings

The user settings can be reset to factory settings.

Note: *PIN code, Loop signal, Messages and Date & Time* will not be reset.

4.6 Safety



In the *Safety* menu you can set the safety settings of the product.

4.6.1 New loop signal

The loop signal is randomly selected to create a unique link between the product and the charging station. In rare cases, there may be a need to generate a new signal, for instance if two adjacent installations have a very similar signal. Put the product in the charging station before you make a new loop signal.

4.6.2 PIN code

When you use the product for the first time you must enter the factory PIN code 1234. You can change the PIN code in the Automower® Connect app. The PIN code must have 4 digits. You can use the numbers 1-4 to set a new PIN code.

4.7 Automower® Connect



In *Automower® Connect* you can enable or disable the Automower® Connect function. You can connect the product to a Wi-Fi network. You can also see the signal strength and connectivity status.

This menu is only available when your mobile device is connected to the product with Bluetooth®.

4.8 Download firmware over the air (Firmware over the air FOTA)

The product has a function that automatically downloads new firmware. The product downloads new firmware when it is parked in the charging station and has Wi-Fi coverage. When a new firmware is available, a notification shows in the app where you can select to install the new firmware.

5 Operation

5.1 To use the ON/OFF button



WARNING: Read and understand the safety chapter before you use the product.

- Push the **ON/OFF** button for 3 seconds to set the product to ON. Make sure that the LED indicator comes on.
- The product is ON and in power save mode if the LED indicator flashes. Push the **ON/OFF** button for 3 seconds to set the product to ON.

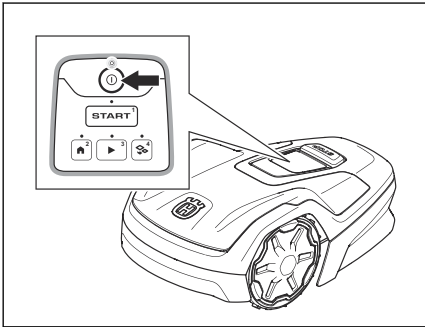

- Push the **ON/OFF** button for 3 seconds to set the product to OFF. Make sure that the LED indicator goes out.

5.1.1 The indicator lamp

The indicator lamps on the keypad show the operating modes of the product, refer to *LED indicator on the keypad on page 9*.

5.2 To start the product

1. Push the **ON/OFF** button for 3 seconds.
2. Use the keypad to enter the PIN code. Refer to *PIN code on page 23*.
3. Select an operating mode. Refer to *Operating modes on page 24*.

Note: The first weeks after installation the perceived sound level when cutting the grass may be higher than expected. When the product has cut the grass for some time, the perceived sound level is much lower.

5.3 Operating modes

The following operating modes are available:

- *Main area*

- *Secondary area*
- *Park*
- *Park / Schedule*
- *Override schedule*

5.3.1 Main area

Main area is the standard operating mode where the product mows and charges automatically.

5.3.1.1 To set the product to operate in Main area

This can be set in the dashboard in the app or with the keypad on the product:

1. Push the **STOP** button.
2. Push the **Play** button.

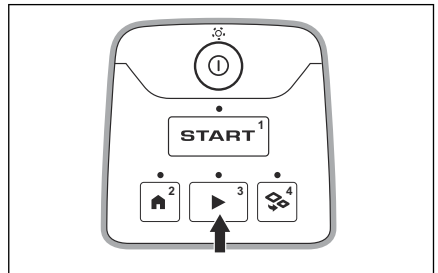

3. Push the **START** button.

5.3.2 Secondary area

To mow secondary areas the operating mode *Secondary area* must be selected. In this mode, the operator must move the product manually between the main area and the secondary area. The product mows until the battery is empty. When the battery is empty, put the product in the charging station to charge the battery. When the battery is charged, the product moves out of the charging station and stops. The product is now prepared to start operation, but needs confirmation from the operator first.

Note: Put the product in the charging station and change the operating mode to *Main area* in the app or with the keypad on the product if you want to cut the main area after the battery is charged.

5.3.2.1 To set the product to operate in Secondary area

This can be set in the dashboard in the app or with the keypad on the product:

1. Push the **STOP** button.
2. Push the **Secondary area** button.

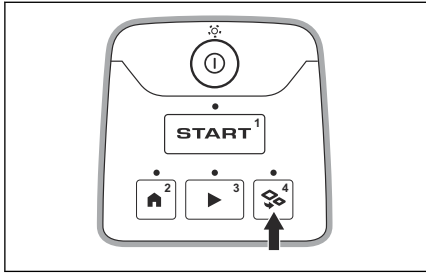

3. Push the **START** button.

5.3.3 Park

Operating mode *Park / Schedule* means that the product goes back to the charging station where it stays until the next schedule. If the product has operated the maximum cutting time for the day, it will start to operate again the next day. Refer to *Make an estimate of the necessary operating time on page 21*.

5.3.3.1 To park the product and start again with the next schedule

This can be set in the dashboard in the app or with the keypad on the product:

1. Push the **STOP** button.
2. Push the **Park** button.

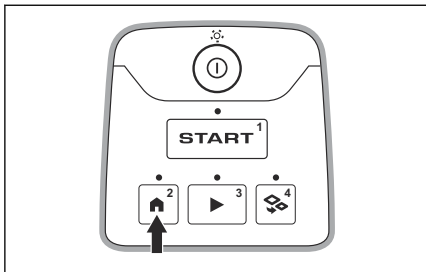

3. Push the **START** button.

Note: To change the operating mode of the product, push the **STOP** button and the product will be in idle mode where you can set an operating mode.

5.3.4 Park until further notice

Use the operating mode *Park until further notice* for the product to go back to the charging station. The product will stay in the charging station until you select a new operating mode.

5.3.4.1 To park the product

This can be set in the dashboard in the app or with the keypad on the product:

1. Push the **STOP** button.
2. Push the **Park** button for 2 seconds.

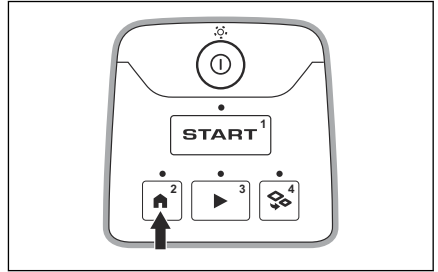

3. Push the **START** button.

Note: To change the operating mode of the product, push the **STOP** button and the product will be in idle mode where you can set an operating mode.

5.3.5 Override schedule

Select *Override schedule* to temporarily override the schedule settings. You can select to override the schedule settings for 3 hours. The product cannot be set to cut more than the maximum cutting time for each day.

5.3.5.1 To override the schedule

This can be set in the dashboard in the app or with the keypad on the product:

1. Push the **STOP** button.
2. Push the **Play** button for 2 seconds.

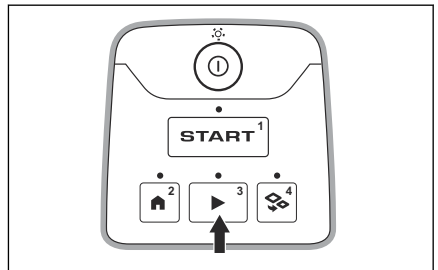

3. Push the **START** button.

5.4 To stop the product

1. Push the **STOP** button on top of the product.

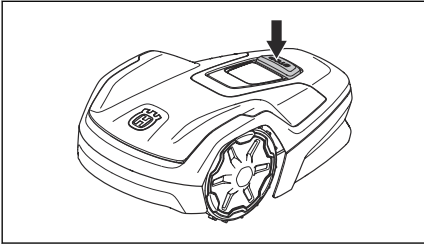

prevent damage to the loop wire. You can then lower the cutting height each week.

You can select between 3 different cutting height steps. The blade disc has marks for each step. Step 1 is the lowest height, step 2 is the middle height, and step 3 is the highest height. The factory setting is set to 3.

5.7.1 To adjust the cutting height



WARNING: Use protective gloves.

1. Push the **ON/OFF** button for 3 seconds to set the product to OFF.
2. Make sure that the product is disabled. The LED indicator on the **ON/OFF** button is not on when the product is disabled. Refer to *Keypad on page 8*.
3. Lift the top cover by the front and remove it.

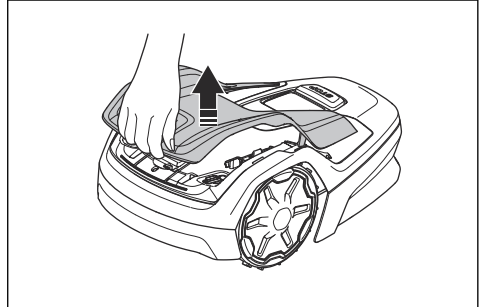

4. Remove the torx key from the body of the product.
5. Put the product with the blade disc up.
6. Remove the 2 screws on the blade disc.
7. Remove the blade disc.

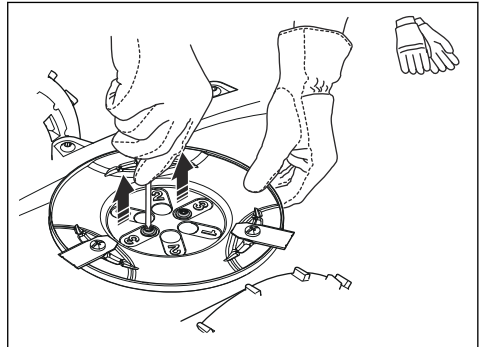

8. Select a cutting height and align the 2 holes on the blade disc with the 2 holes on the shaft.
9. Attach the 2 screws on the blade disc to install the shaft on the blade disc.

Note: When the **STOP** button is pushed the product will be idle. The product stops and the cutting motor stops.

5.5 To set the product to OFF

1. Push the **STOP** button.
2. Push the **ON/OFF** button for 3 seconds to set the product to OFF. Make sure that the LED indicator goes out.

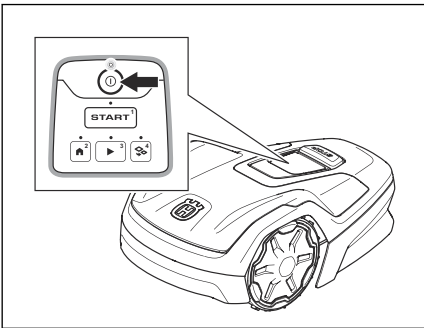

5.6 To charge the battery

When the product is new or after long-term storage, the battery can be empty. Charge the battery before you start the product. In the *Main area* mode, the product cuts and charges automatically.

1. Push the **ON/OFF** button to start the product.
2. Put the product into the charging station until the charging plates touch the contact plates.
3. Make sure that the LED on the **ON/OFF** button pulsates.

5.7 Cutting height adjustment



CAUTION: The first weeks after a new installation, set the cutting height to 3 to

10. Attach the torx key on the body of the product.
11. Attach the top cover on the product.

6 Maintenance

6.1 Introduction - maintenance



WARNING: Set the product to OFF before you do maintenance on the product.



WARNING: Use protective gloves.

For better operation and lifetime of the product, make sure to clean the product regularly and replace worn parts.

When the product is new, examine the blade discs and blades each week. If the wear is low, you can increase the interval for the next time you examine the blade discs and blades. Examine the blade discs and the blades more regularly if there is much wear.

It is important that the blade disc rotates easily and that the edges of the blades are not damaged. The usual lifetime of the blades are 4 to 7 weeks. The conditions that follow can increase or decrease the lifetime of the blades:

- Operation time and dimension of the work area.
- Length and thickness of the grass.
- Soil, sand and use of fertilizers.
- Objects such as cones, tools, stones and roots in the work area.

Note: The cut result can be unsatisfactory if the blades are blunt. Refer to *Replacement of the blades on page 30* on how to replace the blades.

6.2 Maintenance schedule

The maintenance schedule shows how to do servicing and maintenance on the product. Follow the maintenance schedule for a better operation and to increase the lifetime of the product.

X = The instructions are given in this operator's manual.

O = The instructions are not given in this operator's manual. Speak to your approved servicing dealer.

To prepare	Weekly	Every year	Every third year
Clean the product. Refer to <i>Clean the product on page 29</i> .	X		
Examine the product for damage and wear.	X		
Do an update of the firmware.	X		
Do a check of the servicing messages for recommended upgrades.		O	
Servicing			
Examine the blades and replace the blades and blade screws if it is necessary. Refer to <i>Replacement of the blades on page 30</i> .	X		
Examine and polish the contact plates on the charging station.		X	
Examine and polish the charging plates on the product.		X	
Charge the battery fully before you put the product into storage. Refer to <i>To charge the battery on page 26</i> .		X	
Make sure that the product is docking and charging correctly.		O	
Examine and clean the airflow filter.		O	
Replace the airflow filter.			O
Do a check of the tightening torque of chassis screws.		O	
Open the chassis and replace all sealing strips.			O

To prepare	Weekly	Every year	Every third year
Last step			
Use a software service tool to do a function test of the functions of the product.		O	

6.3 Clean the product



CAUTION: Do not use a high-pressure washer to clean the product. Do not use solvents for cleaning.

Husqvarna recommends to use a special cleaning and maintenance kit. Speak to your Husqvarna service for more information.

6.3.1 To clean the chassis and blade disc

Examine the blade discs and blades weekly. Remove the body of the product to clean it fully.

1. Push the **STOP** button.
2. Push the **ON/OFF** button for 3 seconds to set the product to OFF. Make sure that the LED indicator on the keypad goes out.
3. Lift the top cover by the front and remove it.

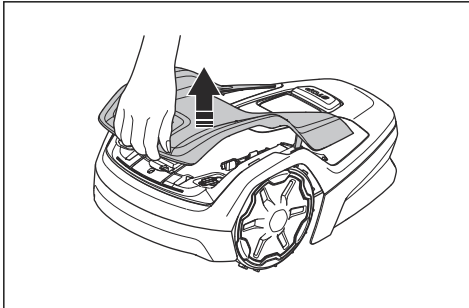

4. Remove the maintenance tool from the body of the product.
5. Hold the rear wheel with one hand.

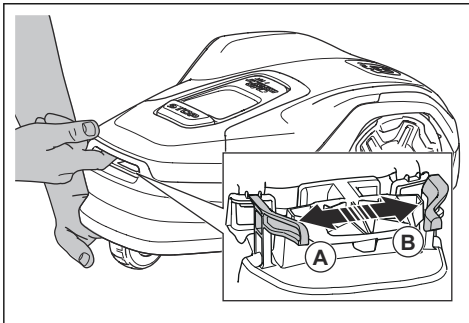

6. Push the back of the hand up to lift the body of the product.

7. With your other hand, push the left clip (A) and then the right clip (B).

Note: You cannot see the clip (A) and (B). You find the clips in the hole at the front of the product.

8. Push the maintenance tool into the 2 holes to loosen the body of the product.

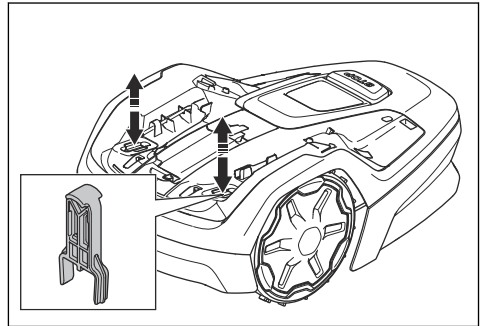

9. Remove the body of the product.
10. Put the product onto its side.
11. Make sure that the blades are not damaged and that the blades and blade discs can rotate freely.
12. Clean the blade discs and chassis with a brush and running water.

6.3.2 To clean the wheels

The product does not operate satisfactorily in slopes if the wheels are blocked with grass.

- Use a soft brush to clean the wheels.

6.3.3 To clean the body of the product

- Use a moist cloth and a weak soap solution to clean the body of the product.

6.3.4 To clean the charging plates and contact plates

1. Use a fine grade emery cloth to clean the charging plates and the contact plates.
2. Lubricate the charging plates and contact plates with oil or grease.

6.3.5 To clean the charging station



WARNING: Disconnect the power supply from the power outlet before maintenance, or when you clean the charging station or power supply.



CAUTION: Do not use a high-pressure washer or running water to clean the charging station.

Note: The product cannot enter the charging station if there are objects in the charging station. Clean the charging station regularly.

- Remove grass, twigs and other objects from the charging station.

6.4 Replacement of the blades



WARNING: Husqvarna can only guarantee safety if you use Husqvarna original blades with the embossed crowned H-mark logotype.

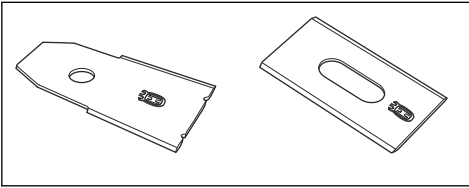

WARNING: You must replace the screws when you replace the blades. The used screws can wear quickly and make the blade come loose, this can cause serious injury.

Replace worn or damaged blades for a safe operation. Replace the blades regularly for a satisfactory cut result and a low energy use. All 3 blades and screws must be replaced at the same time to get a balanced cutting system.

6.4.1 To replace the blades

1. Push the **STOP** button.
2. Push the **ON/OFF** button for 3 seconds to set the product to OFF. Make sure that the LED indicator on the keypad goes off.

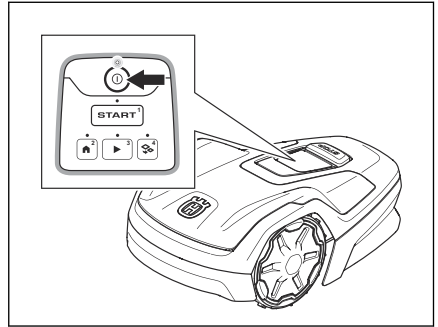

3. Put the product with the blade disc up on a soft and clean surface.
4. Remove the 3 screws.

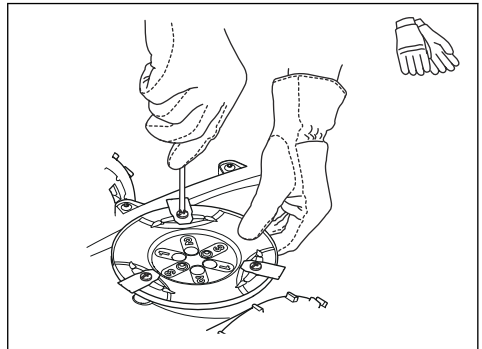

5. Remove each blade and screw.
6. Attach new blades and screws.
7. Make sure that the blades can pivot freely.

6.5 Battery



CAUTION: Charge the battery fully before you put the product into storage. If the battery is not fully charged it can cause damage to the battery.

If the operating time of the product is shorter than usual between charges, this means that the battery is at the end of its life cycle. Replace the battery to extend the operating time.

Note: The battery life is related to the length of the season and how many hours a day the product operates. A long season or many hours of operation a day means that the battery must be replaced more regularly.

6.6 Winter service

Take your product to your Husqvarna service for service prior to winter storage. Regular winter service will maintain the product in good condition and create the best conditions for a new season without any disruptions.

Service usually includes the following:

- Thorough cleaning of the body, the chassis, the blade disc and all other moving parts.
- Testing of the product's function and components.
- Checking and, if required, replacing wear items such as blades and bearings.
- Testing the product's battery capacity as well as a recommendation to replace battery if necessary.
- If new firmware is available, the product is updated.

7 Troubleshooting

7.1 Introduction - troubleshooting

In this chapter you can find information and help about faults and symptoms of the product. You can find more information and FAQ (Frequently Asked Questions) on www.husqvarna.com.

7.2 Fault messages

The fault messages in the table below are shown in the app. Speak to your Husqvarna service if the same message shows frequently.

Message	Cause	Action
<i>Wheel motor blocked, left/right</i>	Grass or other object around the drive wheel.	Remove grass or other object.
<i>Cutting system blocked</i>	Grass or other object around the blade disc.	Remove grass or other object.
	The blade disc is in water.	Move the product and prevent the collection of water in the work area.
	The grass is too high.	Cut the grass before you install the product. Make sure that the grass is maximum 4 cm / 1.6 in.
<i>Trapped</i>	The product is behind a number of obstacles in a small area.	Remove the obstacles or put the boundary wire around the obstacle to make an island. Refer to <i>To make an island on page 15</i> .
<i>Outside working area</i>	A section of boundary wire is put across the other section of boundary wire to the charging station.	Make sure that the boundary wire is connected correctly.
	The boundary wire is too near the edge of the work area.	Make sure that the boundary wire is installed correctly. Refer to <i>To install the boundary wire on page 18</i> .
	The work area slopes much by the boundary loop.	
	The boundary wire is put in the incorrect direction around an island.	
	Interference to the boundary wire from metal objects such as fences, reinforcement steel or buried cables nearby.	Move the boundary wire.
	The product can not find the correct loop signal because of interference with a loop signal from a different product installation nearby.	Put the product in the charging station and generate a new loop signal.

Message	Cause	Action
<i>Empty battery</i>	The product cannot find the charging station.	Change the position of the guide wire. Refer to <i>To install the guide wire on page 18</i> .
	The battery is at the end of its life cycle.	Replace the battery. Speak to your Husqvarna service.
	The antenna of the charging station is defective.	Do a check if the indicator lamp in the charging station flashes red. Refer to <i>Indicator lamp in the charging station on page 37</i> .
	The charging plates on the product or contact plates on the charging station are defective because of corrosion.	Clean the charging plates and contact plates. Refer to <i>To clean the charging plates and contact plates on page 29</i> . If the problem stays speak to your Husqvarna service.
<i>Wrong PIN code</i>	An incorrect PIN code has been entered. 5 tries are permitted, and the product is then blocked for a period of time.	Enter the correct PIN code. If you do not know the correct PIN code, go to www.husqvarna.com to get information about how to get the PIN code or speak to your Husqvarna service.
<i>No drive</i>	The product has got caught in something and has been slipping.	Free the product and correct the cause of problem. If it is because of wet grass, wait until the lawn is dry before you use the product.
	The work area includes a steep slope.	Steep slopes must be isolated. Refer to <i>To examine where to put the boundary wire on page 13</i> .
	The guide wire is not put diagonally in the slope.	Make sure that the guide wire is installed diagonally across the slope. Refer to <i>To put the boundary wire in a slope on page 15</i> .
<i>Wheel motor overloaded, left/right</i>	Grass or other object around the drive wheel.	Remove grass or object from the drive wheel.
<i>Collision sensor problem</i>	The front wheels on the product are blocked.	Free the product and correct the cause of problem. If the problem stays speak to your Husqvarna service.
<i>Charging station blocked</i>	The contact between the charging plates on the product and the contact plates on the charging station is not good. The product has made a number of tries to charge.	Put the product in the charging station and make sure that the charging plates and contact plates are connected.
	An object prevents the product to enter the charging station.	Remove the object.
	The charging station is tilted or bent.	Put the baseplate on level ground.
	The guide wire is not installed correctly.	Install the guide wire correctly. Refer to <i>To install the guide wire on page 18</i> .
	There is dirt on the wheels that prevents the product to enter the charging station.	Clean the product fully.

Message	Cause	Action
<i>Stuck in charging station</i>	An object prevents the product to move out from the charging station.	Remove the object.
	There is dirt on the wheels that prevents the product to enter the charging station.	Clean the product fully.
<i>Upside down</i>	The product is in an incorrect position, the product is tilting too much or is upside down.	Put the product in the correct position.
<i>Lifted</i>	The lift sensor has been enabled because the product has been lifted.	Make sure that the product body can move freely around its chassis. Remove or create an island around objects that can cause the chassis to be lifted. If the problem stays speak to your Husqvarna service.
<i>Wheel drive problem, right/left</i>	Grass or other object around the drive wheel.	Clean the wheels and around the wheels.
<i>Electronic problem</i>	Temporary electronic or firmware related problem in the product.	Restart the product. If the problem stays speak to your Husqvarna service.
<i>Loop sensor problem, front/rear</i>		
<i>Tilt sensor problem</i>		
<i>Temporary problem</i>		
<i>Invalid sub-device combination</i>		
<i>Temporary battery problem</i>		
<i>Safety function faulty</i>		
<i>Charging system problem</i>	Incorrect type of battery.	Use original batteries recommended by the manufacturer.
<i>Battery problem</i>	Temporary battery or firmware related problem in the product.	Restart the product. If the problem stays speak to your Husqvarna service.
	Incorrect type of battery.	Use original batteries recommended by the manufacturer.
<i>Temperature restriction</i>	The temperature in the battery is too high or too low to start operation.	The temperature in the battery is not in its operating limits and charging/mowing has stopped. Charging/mowing will start when the temperature is restored to its limits.
<i>Charging current too high</i>	Incorrect or defective power supply unit.	Restart the product. If the problem stays speak to your Husqvarna service.

Message	Cause	Action
<i>No loop signal</i>	The power supply or low-voltage cable are not connected.	If the LED status indicator on the charging station is not lit, it shows that there is no power. Examine the power outlet connection and the residual-current device. Make sure that the low-voltage cable is connected to the charging station.
	The power supply or low-voltage cable are damaged or not connected.	Replace the power supply or low-voltage cable.
	The boundary wire is not connected to the charging station.	Connect the boundary wire to the charging station. Replace the connectors if damaged. Refer to <i>To install the boundary wire on page 18</i> .
	The boundary wire is damaged.	Do a check of the LED status indicator on the charging station. If it shows damage in the boundary wire, replace the damaged section with new boundary wire.
	The product has tried to start but it is not in the charging station and <i>ECO mode</i> is enabled.	Put the product in the charging station and start the product.
	A section of the boundary wire is across the other section of boundary wire to and from an island.	Install the boundary wire in the correct direction around the island. Refer to <i>To install the boundary wire on page 18</i> .
	Problem with the pairing between the product and the charging station.	Put the product in the charging station and make a new loop signal. Refer to <i>New loop signal on page 23</i> .
	Interference from metal objects such as fences, reinforcement steel or buried cables nearby.	Move the boundary wire and/or make islands in the work area to increase the signal strength.
The product is too far from the boundary wire.	Install the boundary wire to make all parts of the work area maximum 15 m / 50 ft. from the boundary wire.	
<i>Mower tilted</i>	The product is tilted more than the maximum angle.	Move the product to a level area.
<i>Invalid firmware configuration</i>	The firmware in the product is not updated.	Put the product in the charging station and update the firmware via FOTA. If the problem stays speak to your Husqvarna service.

7.3 Information and warning messages

The information messages in the table below are shown in the app. Speak to your Husqvarna service if the same message shows frequently.

Message	Cause	Action
<i>Settings restored</i>	A <i>Reset all user settings</i> has been done.	Usual operation of the product.
<i>FlexiFence problem</i>	The battery of the FlexiFence accessory is low. The FlexiFence does not operate when the battery is empty. The product can cut in the stay-out zone if you start the product before you charge the FlexiFence.	Park the product and charge the FlexiFence accessory before you start the product.
	The temperature in the FlexiFence accessory is a higher than the maximum limit and is set to off.	Put the product in an area with protection from the sun. Let the temperature of the FlexiFence accessory decrease before you start the product.
<i>Guide not found</i>	The guide wire is not connected to the charging station.	Connect the guide wire to the charging station. Refer to <i>To install the guide wire on page 18</i> .
	Damage in the guide wire.	Replace the damaged section with new guide wire.
	The guide wire is not connected to the boundary loop.	Connect the guide wire correctly to the boundary loop. Refer to <i>To install the guide wire on page 18</i> .
<i>Loop signal created</i>	New loop signal changed.	Usual operation of the product.
<i>Needs manual charging</i>	The product is set to the <i>Secondary area</i> operating mode.	Put the product in the charging station.
<i>Next start hh:mm</i>	The schedule setting prevents the product from operating.	Change the schedule settings. Refer to <i>Schedule on page 21</i> .
	The product has operated the maximum cutting time for the day.	Usual operation of the product.
<i>Today's mowing completed</i>	The product has operated the maximum cutting time for the day.	Usual operation of the product. Refer to <i>Schedule on page 21</i> .
<i>Connection NOT changed</i>	The loop signal was not changed because of an error.	Make a <i>New loop signal</i> a number of times. Refer to <i>New loop signal on page 23</i> . If the problem stays speak to your Husqvarna service.

7.4 Indicator lamp in the charging station

The indicator lamp in the charging station must show a solid or flashing green light for a correct installation. If not, follow the instructions in the troubleshooting table below.

Speak to your Husqvarna service for more information.

Light	Cause	Action
Green solid light	Good signals.	Usual operation of the product.
Green flashing light	The signals are good and <i>ECO mode</i> is enabled.	Usual operation of the product. Refer to <i>ECO mode on page 21</i> .
Blue flashing light	The boundary wire is not connected to the charging station.	Make sure that the boundary wire is correctly installed in the charging station. Refer to <i>To install the boundary wire on page 18</i> .
	Damage in the boundary wire.	Find out where the damage is. Replace the damaged section with new boundary wire.
Yellow flashing light	The guide wire is not connected to the charging station.	Make sure that the guide wire is correctly installed in the charging station. Refer to <i>To install the guide wire on page 18</i> .
	Damage in the guide wire.	Find out where the damage is. Replace the damaged section with new guide wire.
Red flashing light	Interference in the antenna of the charging station.	Speak to your Husqvarna service.
Red solid light	Error in the circuit board or incorrect power supply in the charging station. The error must be corrected by your Husqvarna service	Speak to your Husqvarna service.

7.5 Symptoms

If the product does not operate as usual, follow the symptoms table below. Speak to your Husqvarna service if you cannot find the cause for the fault.

Symptoms	Cause	Action
The product has difficulty docking.	The guide wire is not put straight in a line and correct distance from the charging station.	Do a check of the installation of the charging station. Refer to <i>To install the charging station on page 17</i> .
	The guide wire is not put in the slot in the charging station plate.	Make sure that the guide wire is put straight in a line and put in the slot in the charging station plate. Refer to <i>To install the guide wire on page 18</i> .
	The charging station is not on a level surface.	Put the charging station on a level surface. Refer to <i>To examine where to put the charging station on page 12</i> .
	Dirt on the product prevents the product to enter the charging station.	Clean the product fully. Refer to <i>Clean the product on page 29</i> .
	The charging plates on the product or contact plates on the charging station are defective because of corrosion.	Clean the charging plates and contact plates. Refer to <i>To clean the charging plates and contact plates on page 29</i> .
The product operates at the wrong time.	The start and stop times for operating are incorrect.	Change the schedule settings. Refer to <i>Schedule on page 21</i> .
	The time in the product is incorrect.	Set the time in the <i>General</i> menu in the app.
The product vibrates.	The cutting system is not in balance because of damaged blades.	Examine the blades and screws and replace them if necessary. Refer to <i>Replacement of the blades on page 30</i> .
	The cutting system is not in balance because of too many blades in the same position.	Do a check that only one blade is attached to each screw.
	Different thickness of blades are installed on the product.	Do a check if the blades are of different thickness and replace if necessary.
	The cutting disc is not installed correctly.	Make sure that the screws for the cutting disc are attached correctly.
The product operates, but the blade disc does not rotate.	The product searches for the charging station, or is moving to the starting point.	Usual operation for the product. The blade disc does not rotate when the product is searching for the charging station.
The product operates for shorter periods than usual between charges.	Grass or other object causes a blockage to the blade disc.	Remove and clean the blade disc. Refer to <i>To clean the chassis and blade disc on page 29</i> .
	The battery is at the end of its life cycle.	Replace the battery. Speak to your Husqvarna service.
	Blunt blades. More energy is necessary when cutting the grass.	Replace the blades. Refer to <i>Replacement of the blades on page 30</i> .
Mowing and charging times are shorter than usual.	The battery is at the end of its life cycle.	Replace the battery. Speak to your Husqvarna service.

Symptoms	Cause	Action
There is an error with the installation of new firmware via FOTA.	The firmware did not download correctly.	Push a button on the display to start the firmware installation again. If the problem stays speak to your Husqvarna service.
The product is parked for hours in the charging station.	The product has operated the maximum cutting time for the day.	Usual operation for the product. Refer to <i>Make an estimate of the necessary operating time on page 21</i> .
	The STOP button has been pushed.	Enter the PIN code and push the Start button.
	Parking mode is enabled.	Change the operating mode. Refer to <i>Operating modes on page 24</i> .
	The product does not operate if the battery temperature is too high or too low.	Make sure that the charging station is put in an area with protection from the sun.
Uneven mowing results.	The product operates for a small number of hours per day.	Increase the cutting time. Refer to <i>Make an estimate of the necessary operating time on page 21</i> .
	For the shape of the work area it is necessary to adjust the settings for <i>Lawn Coverage</i> to cover all parts of the work area.	Change the settings of the areas where the product starts to cut and how often. Refer to <i>Lawn Coverage and Systematic Passage Mowing on page 22</i> .
	The work area is too large.	Decrease the size of the work area or extend the schedule. Refer to <i>Make an estimate of the necessary operating time on page 21</i> .
	Blunt blades.	Replace all the blades. Refer to <i>Replacement of the blades on page 30</i> .
	Long grass in relation to the set cutting height.	Increase the cutting height and then lower it when the grass is shorter.
	Collection of grass by the blade disc or around the motor shaft.	Remove the collection of grass and clean the product. Refer to <i>Clean the product on page 29</i> .
The battery state of charge is high, but the product goes back to the charging station.	To prevent to become blocked in a small area, the product follows the guide wire to the charging station.	Usual operation for the product.

7.6 Find breaks in the loop wire

Breaks in the loop wire are usually the result of unintentional physical damage to the wire such as when gardening with a shovel. In countries with ground frost, also sharp stones that move in the ground can damage the wire. Breaks can also occur due to the wire being stretched excessively during installation.

Mowing the grass too low right after the installation can damage wire insulation. Damage to the insulation may not cause disruptions until several weeks or months later. To avoid this, always select the maximum cutting height the first weeks after installation and then lower the height one step at a time every second week until the desired cutting height has been reached.

A defective splicing of the loop wire can also lead to disruptions several weeks after the splice was done. A faulty splice can, for example, be the result of the coupler not being pressed together hard enough with a pair of pliers, or that a coupler of lower quality than the original coupler has been used. Please first check all known splices before further troubleshooting is done.

A wire break can be located by gradually halving the distance of the loop where the break may have occurred until there is only a very short section of the wire left.

The following method does not work if *ECO mode* is activated. Make sure first that *ECO mode* is switched off. Refer to *ECO mode on page 21*.

1. Check that the indicator lamp in the charging station flashes blue, which indicates a break in the boundary loop. Refer to *Indicator lamp in the charging station on page 37*.
2. Check that the boundary wire connections to the charging station are properly connected and not damaged. Check that the indicator lamp in the charging station is still flashing blue.
3. Switch the connections between the guide wire and the boundary wire in the charging station.

Start by switching connection L and GUIDE.

If the indicator lamp is flashing yellow, then the break is somewhere on the boundary wire between L and the point where the guide wire is connected to the boundary wire (thick black line in the illustration).

To rectify the fault you will need boundary wire, connector(s) and coupler(s):

- a) If the suspected boundary wire is short then the easiest way is to exchange all of the boundary wire between L and the point where the guide wire is connected to the boundary wire (thick black line).
- b) If the suspected boundary wire is long (thick black line) then do as follows: Put L and GUIDE back to their original positions. Then disconnect R. Connect a new loop wire to R. Connect the other end of this new loop wire at the middle of the suspected wire section.

If the indicator lamp now is flashing yellow, then the break is somewhere in the wire between the disconnected end to the point where the new wire is connected (thick black line below). In that case, move the connection for the new wire closer to the disconnected end (roughly at the middle of the suspected wire section) and check again if the indicator lamp is green.

Continue until only a very short section of the wire remains which is the difference between a solid green light and a flashing blue light. Then follow instruction in step 5 below.

4. If indicator lamp still flashes blue in step 3 above: Put L and GUIDE back in their original positions. Then switch R and GUIDE. If indicator lamp now is lit with a solid green light then disconnect L and connect a new boundary wire to L. Connect the other end of this new wire at the middle of the suspected wire section. Follow the same approach as in 3a) and 3b) above.
5. When the break is found, the damaged section must be replaced with a new wire. Always use original couplers.

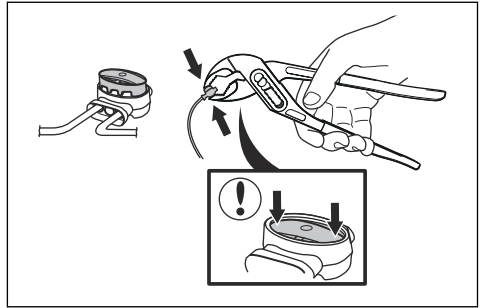

8 Transportation, storage and disposal

8.1 Transportation

The supplied Li-ion batteries obey the Dangerous Goods Legislation requirements.

- Obey all applicable national regulations.
- Obey the special requirement on package and labels for commercial transportations, including by third parties and forwarding agents.

8.2 To put the product into storage

- Fully charge the product. Refer to *To charge the battery on page 26*.
- Set the product to OFF. Refer to *To set the product to OFF on page 26*.
- Clean the product. Refer to *Clean the product on page 29*.
- Keep the product in a dry, frost free space.
- Keep the product with all wheels on level ground or hang it on the wall with the storage hook. Refer to *To install the storage hook on the wall on page 41*.
- If you keep the charging station indoors, disconnect and remove the power supply and all the connectors from the charging station. Put the end of each connector wire in a connector protection box.

Note: If you keep the charging station outdoors, do not disconnect the power supply and the connectors.

- Speak to your Husqvarna service for information about available storage accessories for your product.

8.2.1 To install the storage hook on the wall

- Install the storage hook indoors.
- Keep the storage hook out of sunlight.
- Install the storage hook on a drywall, wood or concrete wall.



CAUTION: Make sure that the wall can hold loads of minimum 30 kg.

- Remove the drill template from the carton of the product to use it to install the storage hook on the wall.
- Install the storage hook on the wall with the 3 screws (A). Use wall plugs (B) if it is necessary.

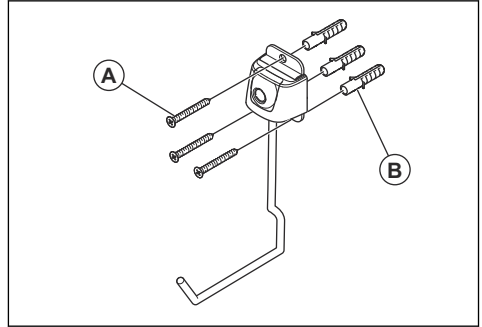

CAUTION: Make sure that the screws are applicable for your wall type.

- Speak to your Husqvarna service agent for information about available storage accessories for your product.

8.3 Disposal

- Obey the local recycling requirements and applicable regulations.



CAUTION: Only remove the battery when you dispose the product. The Husqvarna warranty is not applicable if you remove the warranty seal.

8.3.1 To remove the battery



WARNING: Use protective gloves.



CAUTION: Do not touch the circuit boards.

1. Push the **ON/OFF** button for 3 seconds to switch off the product.
2. Make sure that the product is disabled. The indicator lamp on the **ON/OFF** button is not on when the product is disabled. Refer to *LED indicator on the keypad on page 9*.
3. Put the product with the blade disc up.
4. Remove the 10 screws with a Torx 20.

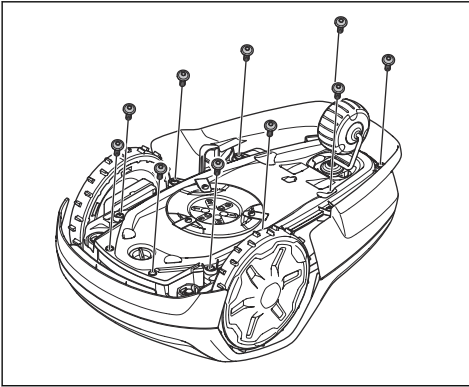

5. Carefully lift the lower section of the chassis and put it adjacent to the upper chassis.



CAUTION: Be careful, the cable is connected to the main board.

6. Disconnect the battery cable from the main circuit board.

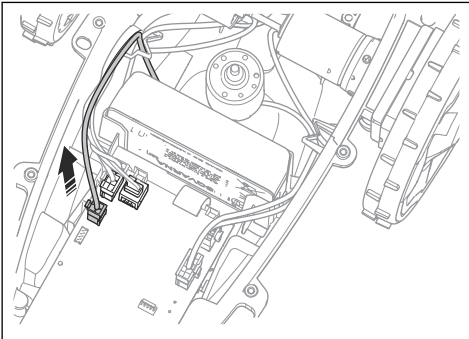

7. Use a screwdriver to push the clips on each side of the battery to remove it.

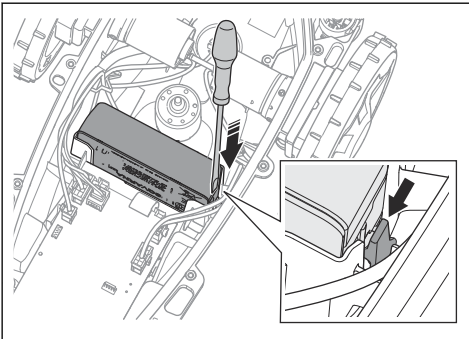

9 Technical data

9.1 Technical data

Dimensions	Automower® Aspire™ R4
Length, cm / in.	55 / 21.7
Width, cm / in.	33 / 13.0
Height, cm / in.	22 / 8.7
Weight, kg / lb	5.9 / 13.0

Electrical system	Automower® Aspire™ R4
Battery, Lithium-Ion 18 V/2.0 Ah Art.No	590 21 42-02, 590 21 42-04, 590 21 42-06, 590 21 42-10
Battery, Lithium-Ion 18.25 V/2.0 Ah Art.No	590 21 42-03
Battery, Lithium-Ion 18.5 V/2.0 Ah Art.No	590 21 42-07, 590 21 42-08, 590 21 42-09, 590 21 42-11
Power supply (28V DC), V AC	100-240
Low-voltage cable length, m / ft.	5 / 16.4
Mean energy consumption at maximum use	3 kWh/month in a 400 m ² work area
Charge current, A DC	1 / 1.3
Type of Power Supply Unit ¹⁰	ADP-28AW XX, ADP-28AR XX, ADP-40KR XX, ADP-40FW XX, FW7313/28/D/XX/Y/1.0/PI, FW7313/28/D/XX/Y/1.3, FW7313/28/D/XX/Y/1.3/PI
Average mowing time, min	70
Average charging time, min	75 / 60

Boundary wire antenna	Automower® Aspire™ R4
Operating Frequency Band, Hz	100-80000
Maximum magnetic field ¹¹ , dBuA/m	82
Maximum Radio-frequency power ¹² , mW @60m	<25

¹⁰ XX, YY can be any alphanumeric characters or blank for marketing purpose only, no technical differences.

¹¹ Measured according to EN 303 447.

¹² Maximum active output power to antennas in the frequency band in which the radio equipment operates.

Sound data ¹³	Automower® Aspire™ R4
Sound level, perceived, dB (A)	59
Measured sound power noise level, dB (A)	58
Noise emissions uncertainties K_{WA} , dB (A)	2
Sound pressure noise level at the operator's ear ¹⁴ , dB (A)	50

Mowing	Automower® Aspire™ R4
Area capacity m ² / acre +/- 20%	400 / 0.1
Cutting system	3 pivoted cutting blades
Cutting motor speed, rpm	2670
Power consumption during cutting, W +/- 20 %	20
Cutting height, cm / in.	2-4.5 / 0.8-1.8
Cutting width, cm / in.	16 / 6.3
Narrowest possible passage, cm / in.	60 / 24
Maximum slope for cutting area, %	25
Maximum slope for boundary wire, %	10
Maximum length boundary wire, m / ft.	300 / 980
Maximum length guide loop ¹⁵ , m / ft.	150 / 490

IP-code	Automower® Aspire™ R4
Product	IPX5
Charging station	IPX5
Power supply	IPX4/IP44

Bluetooth®	Automower® Aspire™ R4
Operating frequency band, MHz	2402-2480
Maximum transmitted power, dBm	9

Wi-Fi	Automower® Aspire™ R4
Frequency band support ¹⁶	Channel 1-11 (2412-2462 MHz)
	Channel 12-13 (2467-2484 MHz)
	Channel 14
Operating frequency band, MHz	2402-2480
Maximum transmitted power, dBm	20

¹³ Determined according to Directive 2006/42/EC and standard EN 50636-2-107. Except Sound level, perceived that is measured according to ISO 11094:1991.

¹⁴ Sound pressure noise uncertainties K_{pA} , 2-4 dB (A)

¹⁵ The guide loop is the loop that is formed by the guide wire and the part of the boundary wire from the junction with the guide wire to the right connection in the charging station.

¹⁶ Channel 12-14 only used in countries where it is available.

Husqvarna AB does not guarantee full compatibility between the product and other types of wireless systems such as remote controls, radio transmitters, hearing loops, underground electric animal fencing or similar.

The products are made in England or the Czech Republic. Refer to information on the rating plate. Refer to *Introduction on page 6*.

9.2 Registered trademarks

The *Bluetooth*[®] word mark and logos are registered trademarks owned by *Bluetooth SIG, inc.* and any use of such marks by Husqvarna is under license.

The Wi-Fi CERTIFIED[™] logo is a registered trademark of Wi-Fi Alliance[®]. This product is Wi-Fi Alliance[®] certified.



10 Warranty

10.1 Warranty terms

Husqvarna warranty covers this product's functionality for a period of 2 years from date of purchase. The warranty covers serious faults relating to materials or manufacturing faults. Within the warranty period, we will replace the product or repair it at no charge if the following terms are met:

- The product and the charging station may only be used in compliance with the instructions in this Operator's Manual. This manufacturer's warranty does not affect warranty entitlements against the dealer/retailer.
- End-users or non-authorized third parties must not attempt to repair the product.

Examples of faults which are not included in the warranty:

- Damage caused by water seepage from using a high-pressure washer, or from being submerged under water, for example when heavy rain forms pools of water.
- Damage caused by lightning.
- Damage caused by improper battery storage or battery handling.
- Damage caused by using a battery that is not a Husqvarna original battery.
- Damage caused by not using Husqvarna original spare parts and accessories, such as blades and installation material.
- Damage to the loop wire.
- Damage caused by non-authorized changing or tampering with the product or its power supply.

The blades and wheels are seen as disposable and are not covered by the warranty.

If an error occurs with your Husqvarna product, please contact Husqvarna service for further instructions. Please have the receipt and the product's serial number at hand when contacting Husqvarna service.



www.husqvarna.com

Original instructions



1143079-26



2023-02-17